



BS&B SAFETYSYSTEMS, INC.
BS&B SAFETYSYSTEMS LTD.

SVI * RUPTURE DISK ASSEMBLY INSTALLATION INSTRUCTIONS

BULLETIN
77-4005I

- ◆ **RETROFIT** -- This unit is specifically designed to isolate safety relief valves from the process media and keep the fluid from leaking to the atmosphere.
- ◆ **ORDER REPLACEMENT DISKS BY LOT NUMBER.**

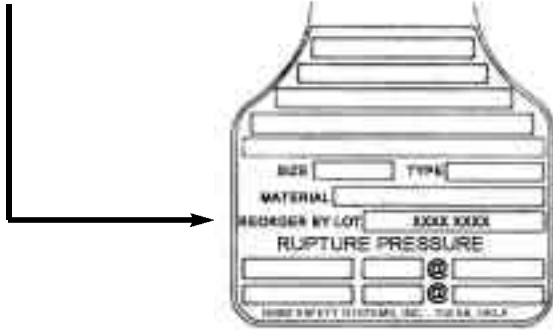

*Patent applied for

INSTALL THE SVI ASSEMBLY

Follow Steps below for proper installation:

STEP I: Remove relief valve from piping. Drill and tap the valve's inlet nozzle for the telltale indicator. Mounting can be done after valve installation.

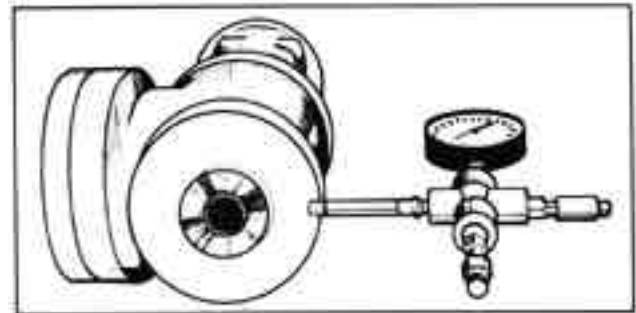

STEP I

STEP II: Position 1/16" thick compressed fiber service sheet gasket (supplied unnotched gasket) on inlet of the SVI housing flange.

NOTE: If Teflon boot is used for corrosive conditions, the boot slips over the SVI first and then the gasket over the boot.

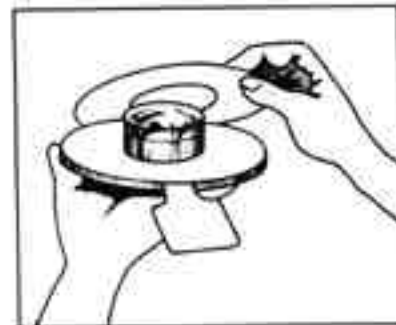

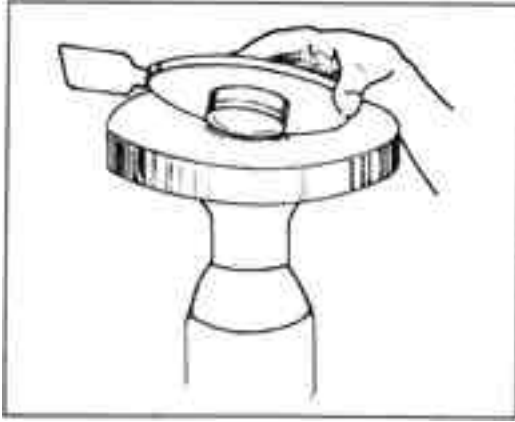

STEP III: Insert SVI unit into inlet piping so that system pressure will be against convex side of disk.

STEP IV: Place the second gasket (notched) on top of the exposed SVI flange. The flat or notch of the gasket should be positioned toward the name plate.

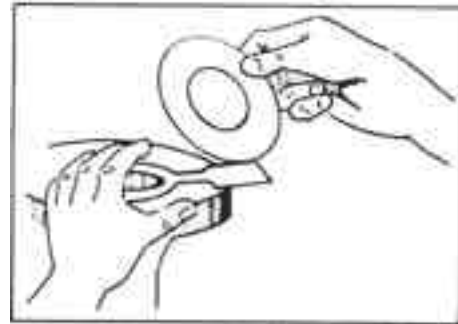

STEP V: Replace safety relief valve to its original position. Take precautions that SVI unit and gaskets are centered with inlet piping and valve. Install telltale indicator at this time. Torque down studs and nuts per the following table.

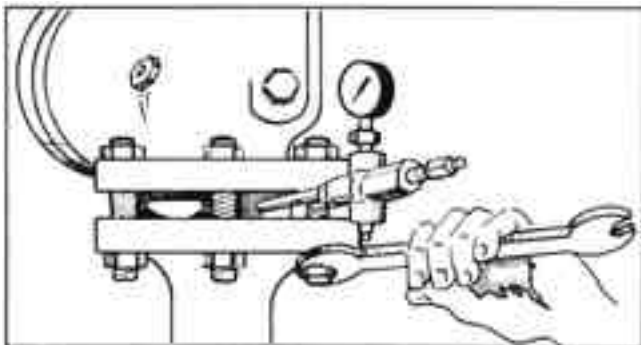

SVI DISK SIZE	COMPANION FLANGE ASA RATING	TORQUE
1 1/2"	150	21 Ft. Lbs.
	300, 400, 600	75 Ft. Lbs.
2"	150	42 Ft. Lbs.
	300, 400, 600	
2 1/2"	150	42 Ft. Lbs.
	300, 400, 600	75 Ft. Lbs.
3"	150	42 Ft. Lbs.
	300, 400, 600	75 Ft. Lbs.
4"	150	42 Ft. Lbs.
	300	75 Ft. Lbs.
	400, 600	122 Ft. Lbs.
6"	150	75 Ft. Lbs.
	300	
	400	122 Ft. Lbs.
	600	183 Ft. Lbs.

NOTE: Corrosion and service conditions may affect disk life thus requiring periodic change.

SVI units are designed to be installed between the valve inlet flange and the mating ANSI flange in schedule 80 and lighter piping.

NOTE: Disk units should be used in accordance with the ASME Boiler and Pressure Vessel Code, Section VIII Div. I UG-127-134 and Footnote 39 of the ASME Code which states:

“The space between a rupture disk device and a safety or safety relief valve shall be provided with a pressure gauge, a try cock, free vent, or suitable telltale indicator. This arrangement permits detection of disk rupture or leakage.”

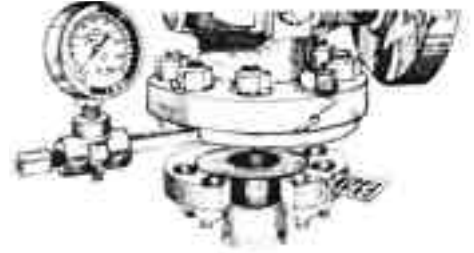

“Users are warned that a rupture disk will not burst at its design pressure if back pressure builds up in the space between the disk and the safety or safety relief valve which will occur should leakage develop in the rupture disk due to corrosion or other cause.”

The SVI slips into existing piping and requires no Safety Heads. ASME Code requires a tell-tale indicator to be used with rupture disks and safety relief valves in series.

This is the reason for the telltale indicator. When testing safety relief valves in place, system pressure should be a minimum of 20% of safety valve set pressure to prevent possible damage to SVI disk.

SPECIFICATIONS FOR SVI* RUPTURE DISKS AT 72° F

NOMINAL PIPE SIZE (INCHES)	SVI SIZE (INCHES)	DISK BURST PRESSURES PSIG			
		ALLOY 200 (NICKEL)		ALLOY 600 (INCONEL)	
		MIN	MAX	MIN	MAX
1 1/2	1 1/2	80	400	150	400
2	2	68	400	110	400
2 1/2	2 1/2	68	400	110	400
3	3	54	350	90	350
4	4	46	300	72	300
6	6	35	250	60	250

ENGINEERING INFORMATION

Minimum and maximum pressure ratings are applicable at 72° F.

All SVI flanges are 316 stainless steel.

Manufacturing Range:

1. Alloy 600 (Inconel) and Alloy 200 (nickel) rupture disks are available with 5% and 10% manufacturing range.

2. The total manufacturing range is placed on the minus side of the requested burst pressure.

Example:

If a 200 psig SVI is ordered with a 10% manufacturing range, it may be tagged at any pressure between 200 psig and 180 psig.

Burst Tolerances:

Burst tolerances are the maximum variation from the above tagged burst pressure.

Disks tagged above 40 psig. Burst Tolerance +/- 5%.

Disks tagged 40 psig and below: +/- 2 psi.

Recommended maximum temperatures for each metal are:

Alloy 600 (Inconel): 900° F.

Alloy 200 (Nickel): 750° F.

WARRANTY

“THE EXPRESSED WARRANTIES HEREINAFTER GIVEN BY BS&B SAFETY SYSTEMS, INC. ARE EXCLUSIVE AND IN LIEU OF ALL WARRANTIES EXPRESSED OR IMPLIED, BY OPERATION OF LAW OR OTHERWISE, INCLUDING, WITHOUT LIMITATION ANY IMPLIED WARRANTY OF MERCHANTABILITY OR OF FITNESS FOR A PARTICULAR PURPOSE.

BS&B Safety Systems, Inc. warrants its products against defective workmanship and material under normal and proper use in service for twelve (12) months of the date of shipment when owned by the original purchaser and only when subjected to normal operating conditions outlined by purchaser when order is placed: except that, rupture disks are not guaranteed except to burst within specified pressure ranges at temperatures specified at time of sale.

Where the products involved include a rupture disk inside a rupture disk holder, each must be of the proper type to be utilized with its mating part as otherwise recommended by and manufactured by BS&B. Substitution of either a rupture disk or rupture disk holder not manufactured by BS&B voids the aforementioned warranty and BS&B SPECIFICALLY DISCLAIMS ANY AND ALL LIABILITY FOR DAMAGES, EITHER DIRECT OR INDIRECT, INCIDENTAL OR CONSEQUENTIAL, ARISING FROM THE USE OF ASSEMBLIES NOT WHOLLY COMPRISED OF BS&B MANUFACTURED PRODUCTS.

Except for the express warranty set forth herein, BS&B shall have no obligations or liabilities connected with or resulting from the sale, installation or use of the equipment supplied by BS&B and final determination of the suitability of the products for the use contemplated by the Buyer is the sole responsibility of the Buyer.”

There is no guarantee against corrosion or erosion caused by acids, chemicals, their fumes, or the like.



BS&B Safety Systems, Inc. and BS&B Safety Systems Ltd. are here to assist you in providing a safe and efficient work place. For assistance on installation, audits, training or technical advice, please contact our Customer Service Department.

BS&B Safety Systems, Inc.
7455 East 46th Street
Tulsa, OK 74145
Telephone: 918-622-5950
Facsimile: 918-665-3904
www.bsbsystems.com

or

BS&B Safety Systems Ltd.
Raheen Business Park
Raheen, Limerick, Ireland
Telephone: +353 61 227022
Facsimile: +353 61 227987
www.bsb.ie